

lalka
лялька

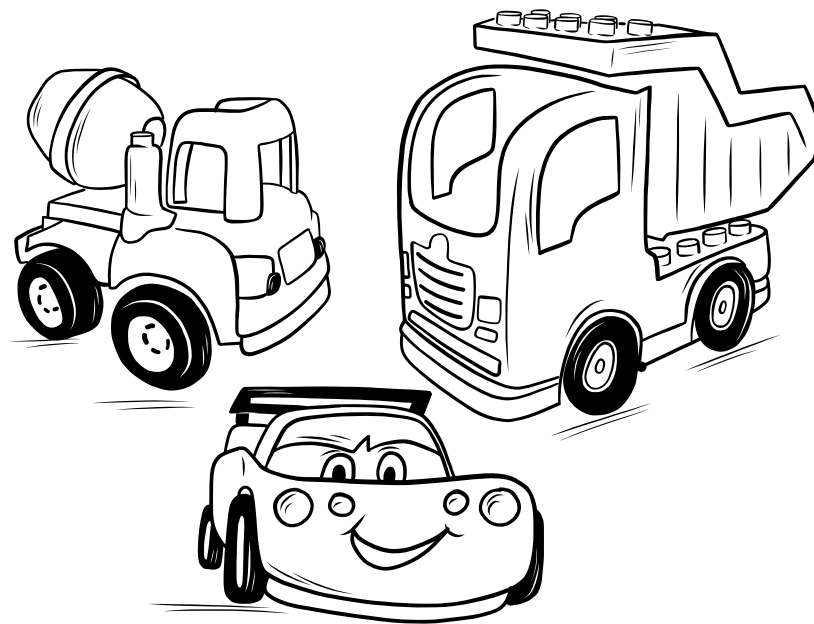

autko
машина

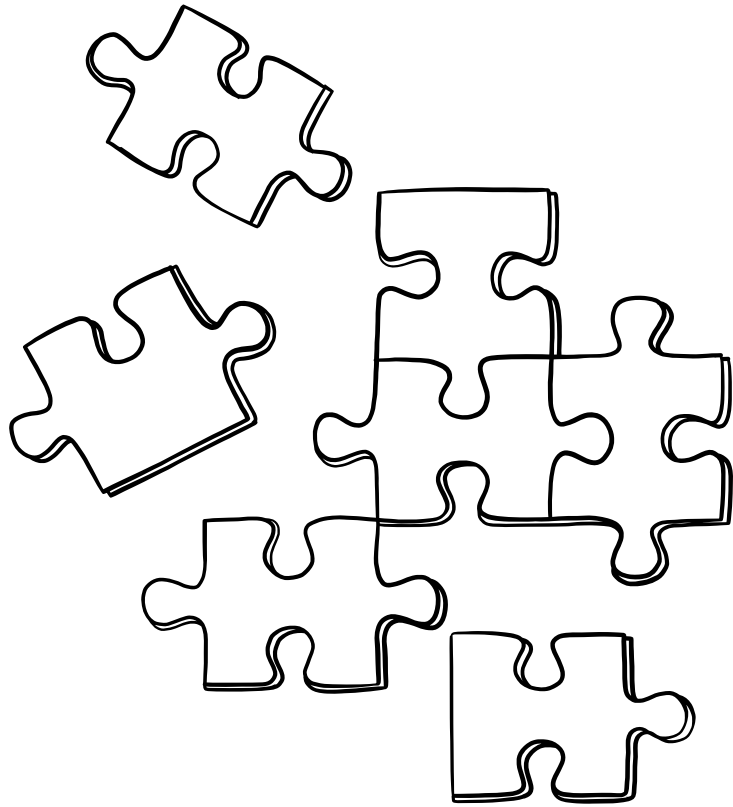

puzzle
пазл

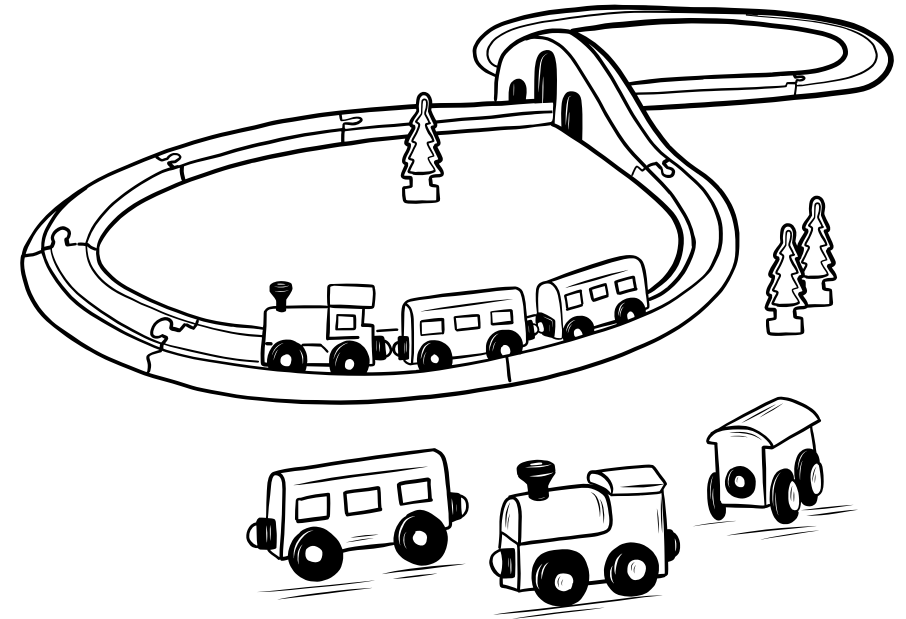

rociąg
поїзд

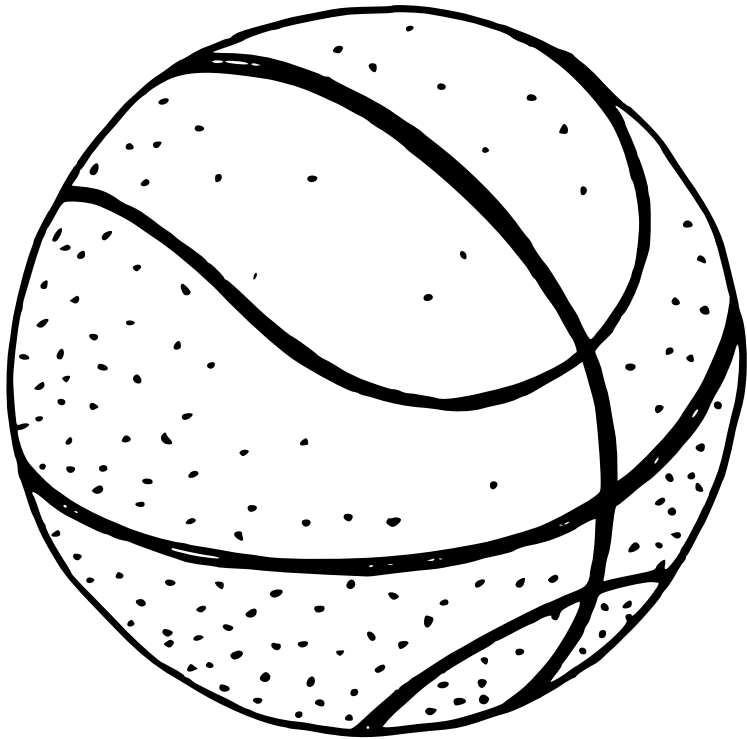

piłka
м'яч



kolorowanki
розмальовки



picie
напій

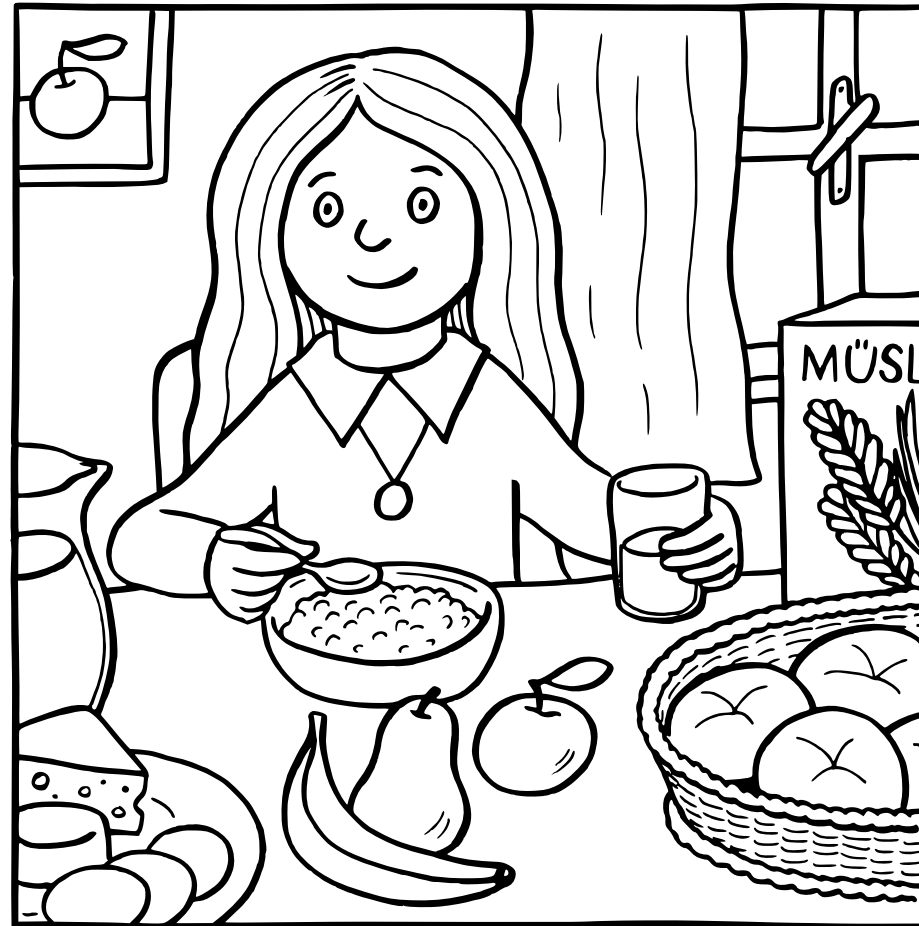

śniadanie
сніданок



przekąska
перекуска

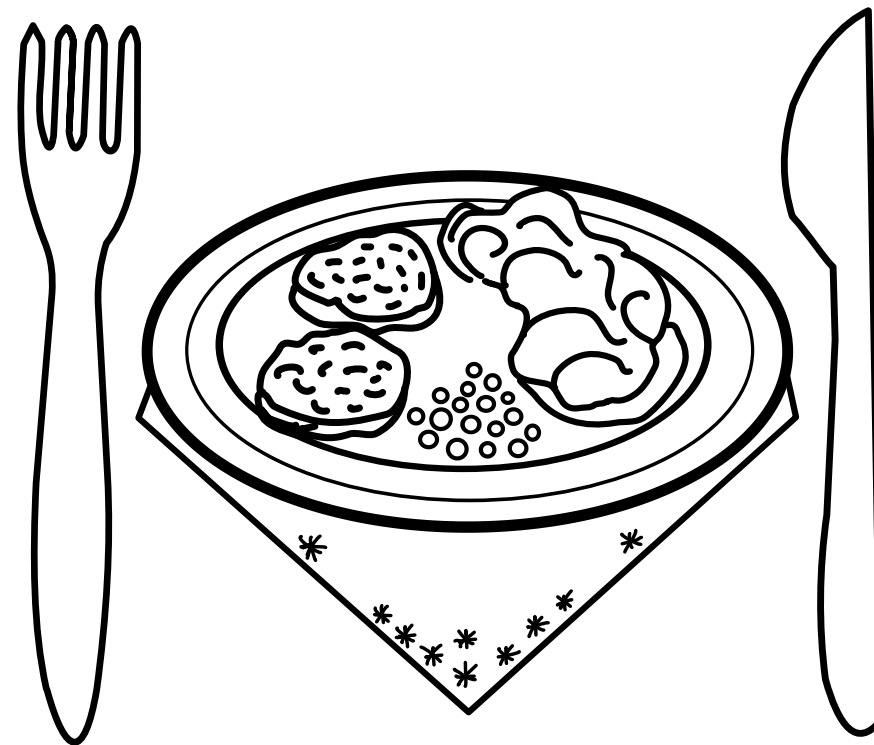

obiad
обід

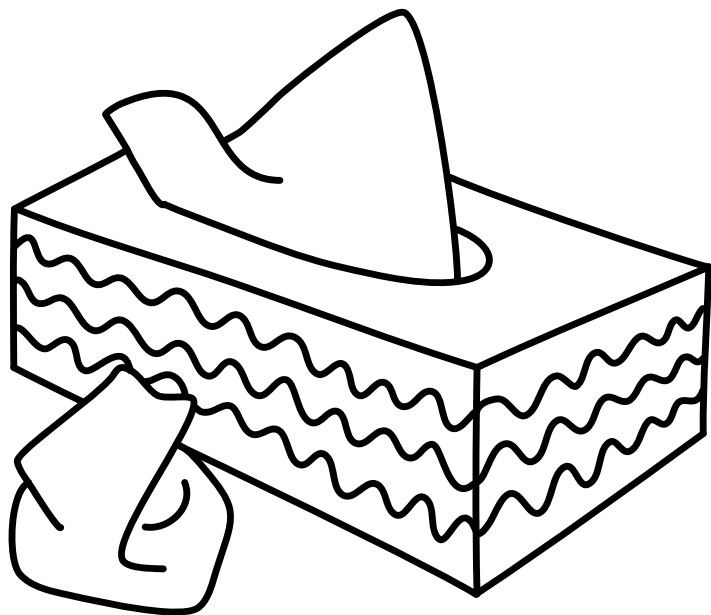

chusteczka do nosa
НОСОВА ХУСТИНКА

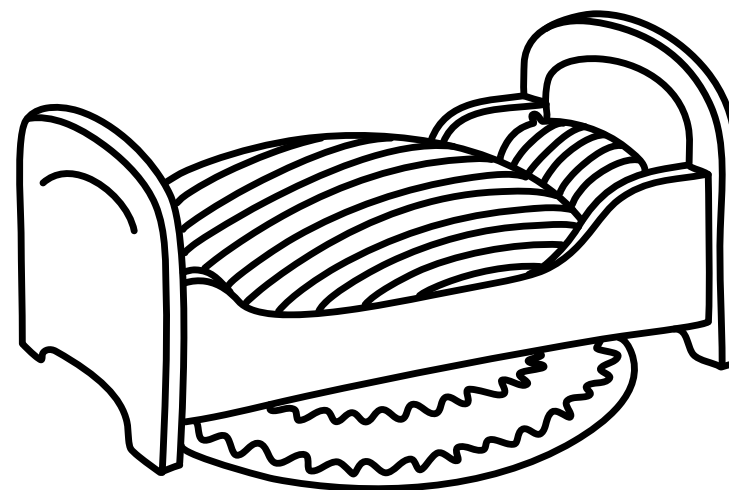
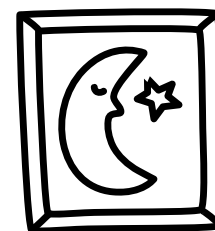

łóżko
ЛІЖКО



toaleta
туалет

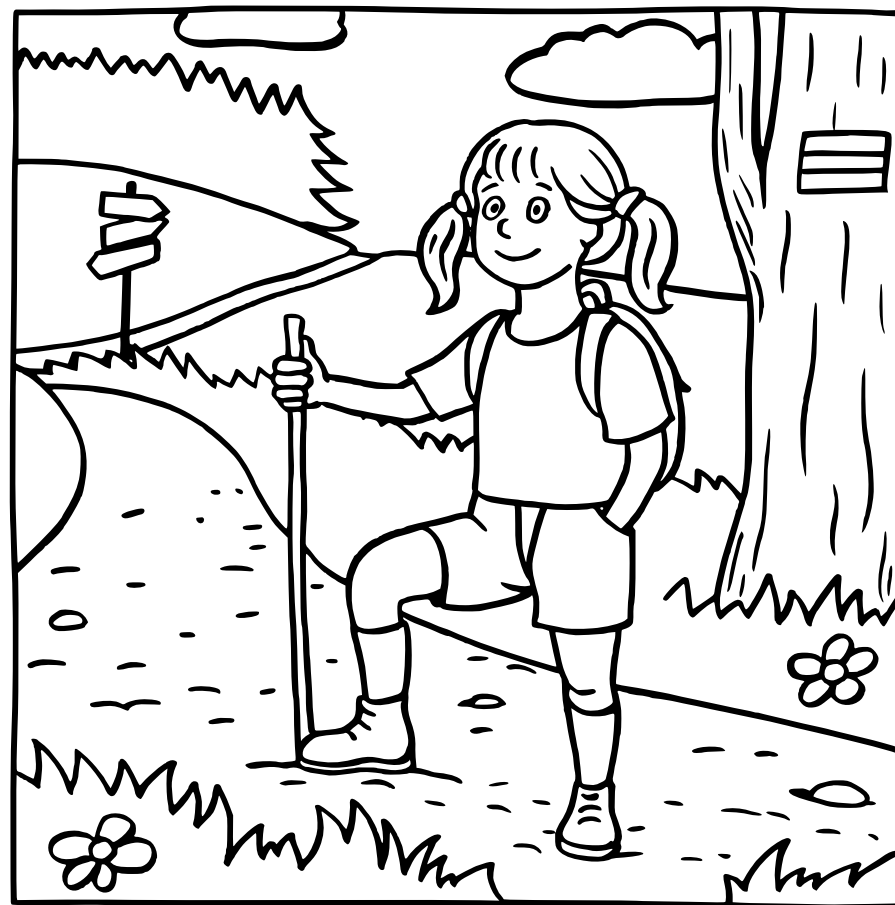

wycieczka
подорож



ogród
сад

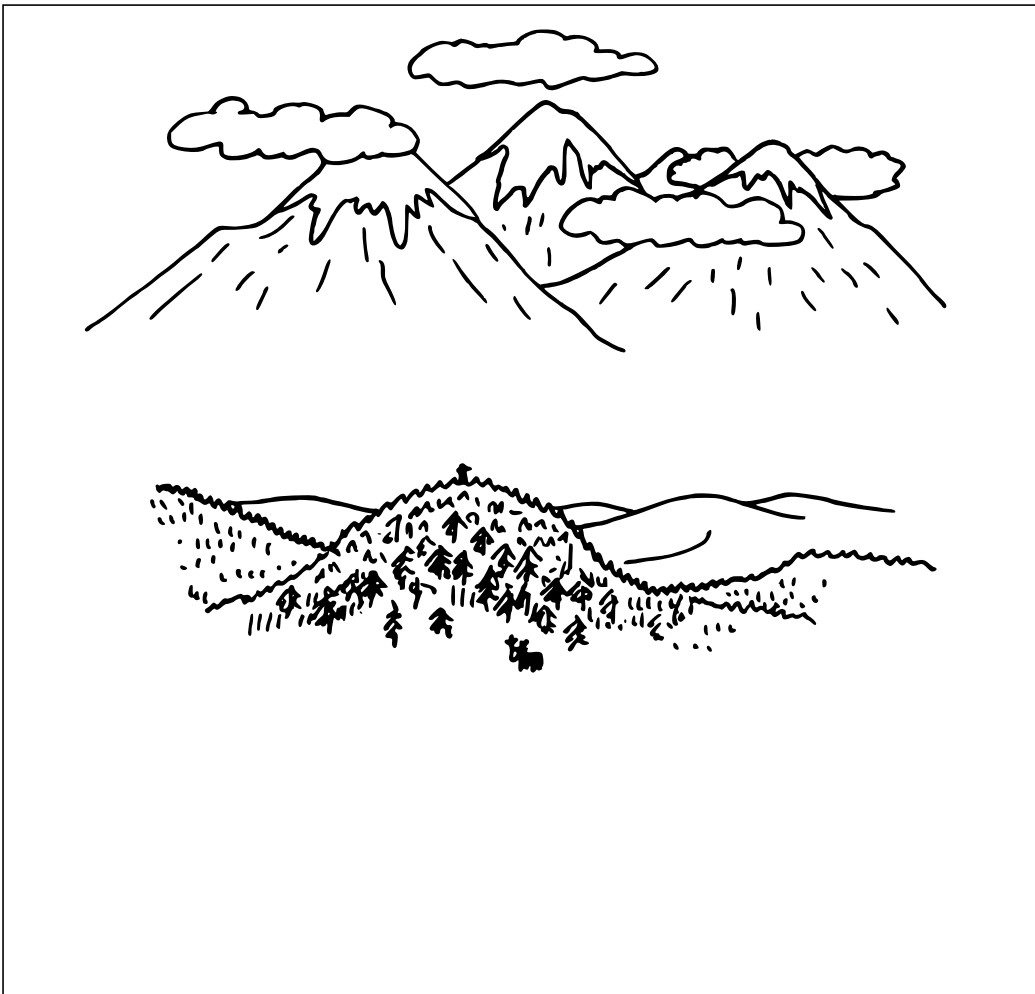

góry
гори



jeździć na łyżwach
кататися на
ковзанах

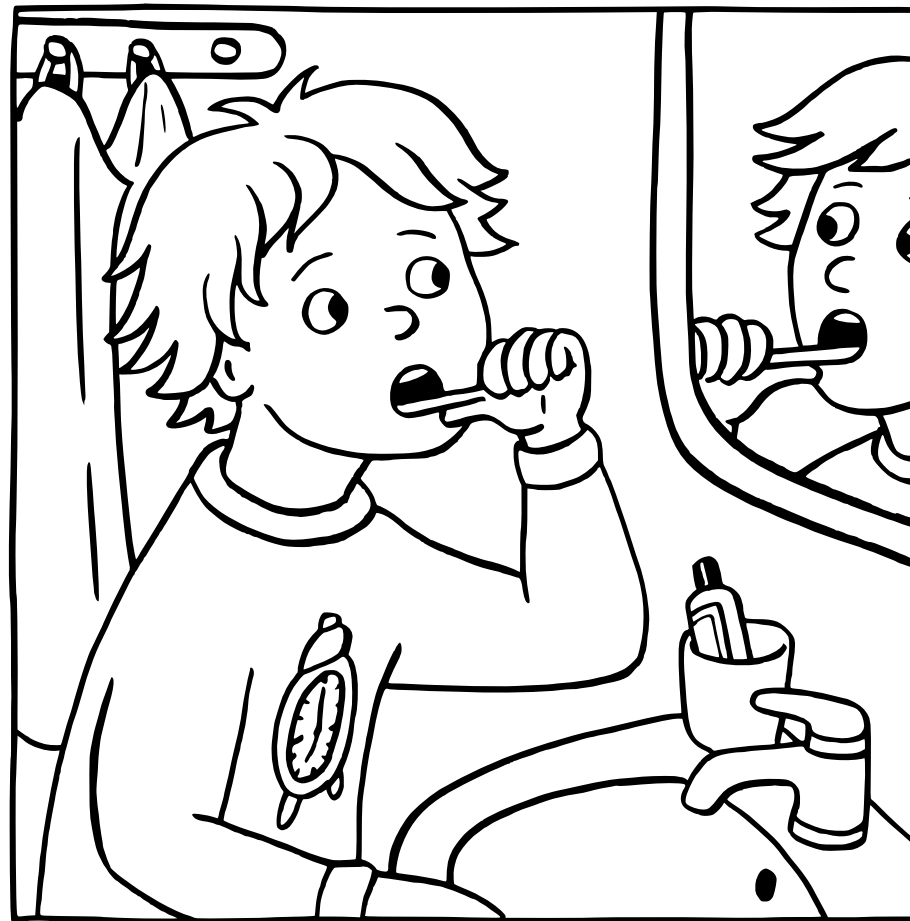

myć zęby
чистити зуби



ćwiczyć
робити вправи



Boli mnie brzuszek.
У мене болить
живіт.

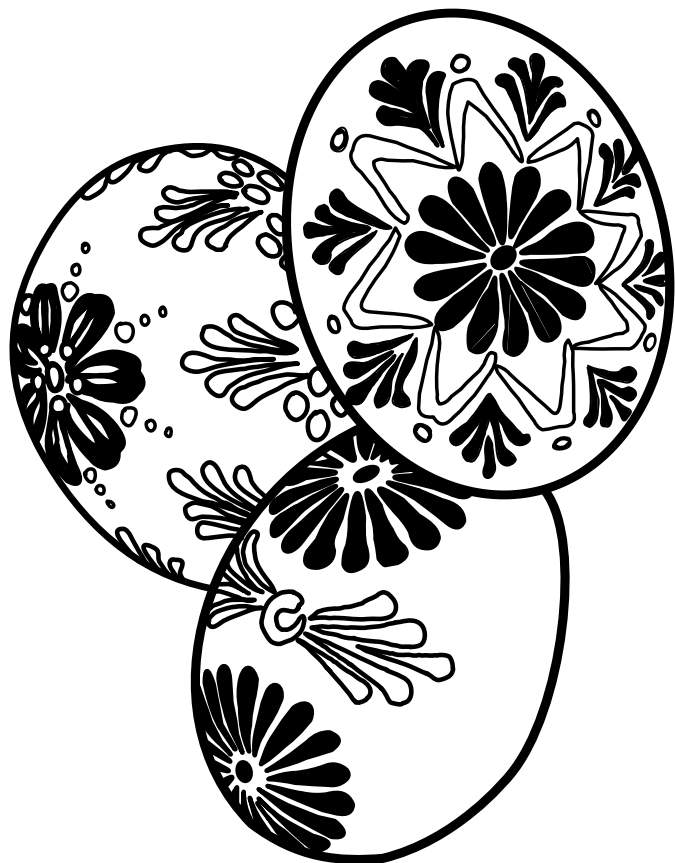

pisanka
писанка



zajączek
зайчик

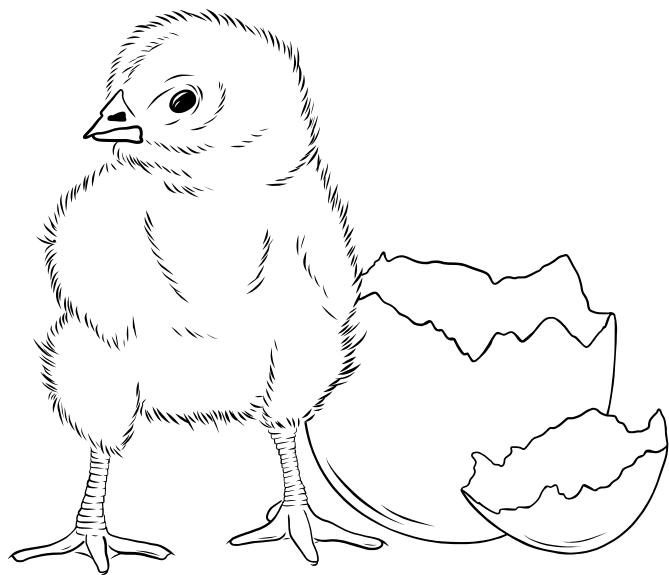

pisklę
курчатко

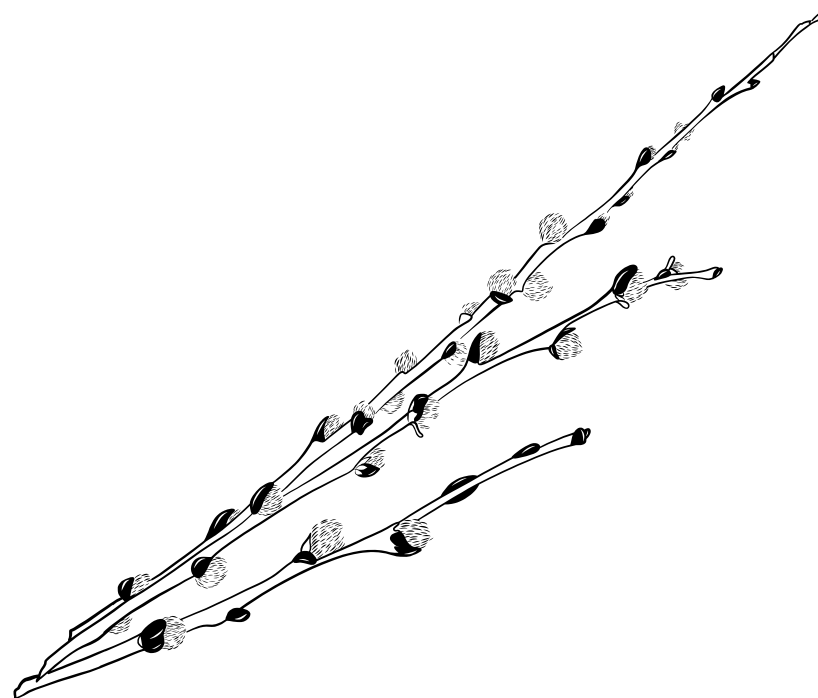

kotki (kwiaty
wierzby)
КОТИКИ (цвіт верби)



baranek
баранець



pierwiosnek
примула



tulipany
ТЮЛЬПАНИ

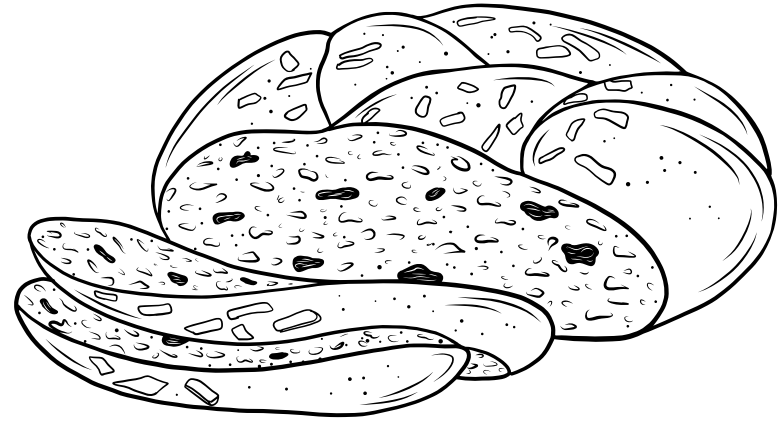

mazurek
пасочка



mak
мак



dmuchawiec
кульбаба



lilak
бузок



słonecznik
соняшник

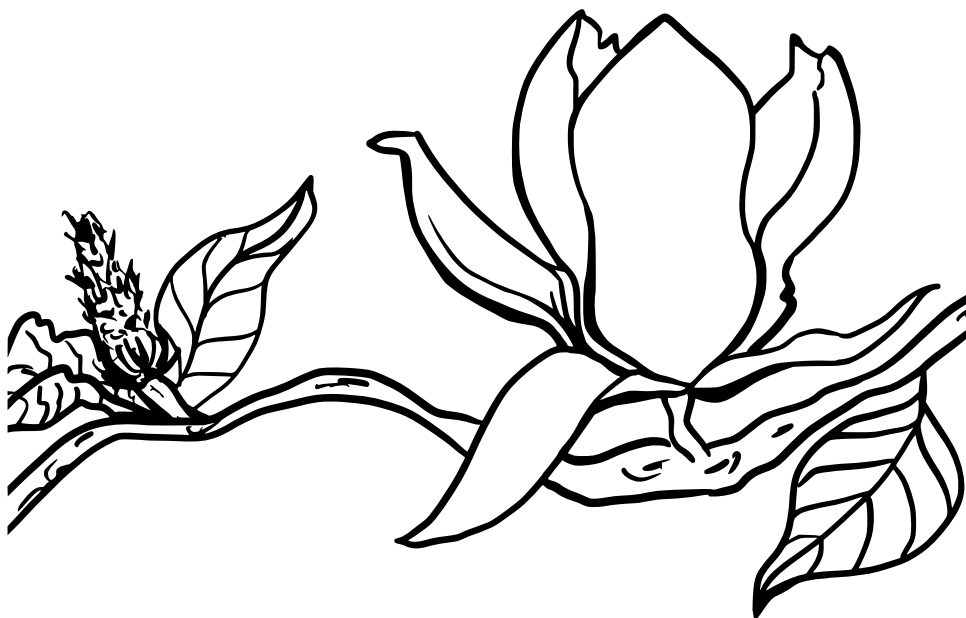

magnolia
магнолія



odważny rycerz
хоробрий лицар



piękna królewna
прекрасна
принцеса



król
король

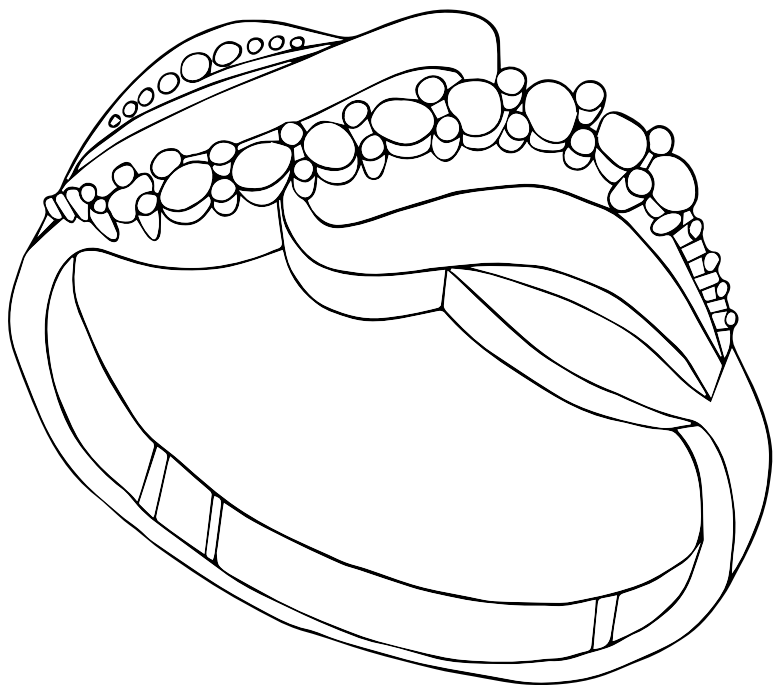

złoty pierścień
золотий перстень

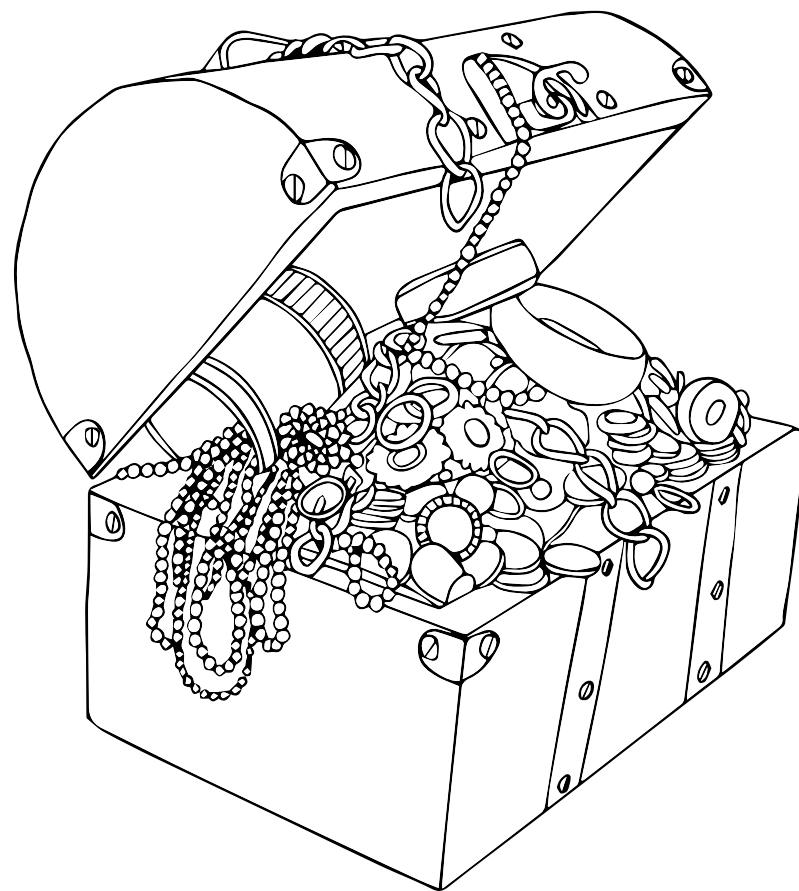

skarb
скарб

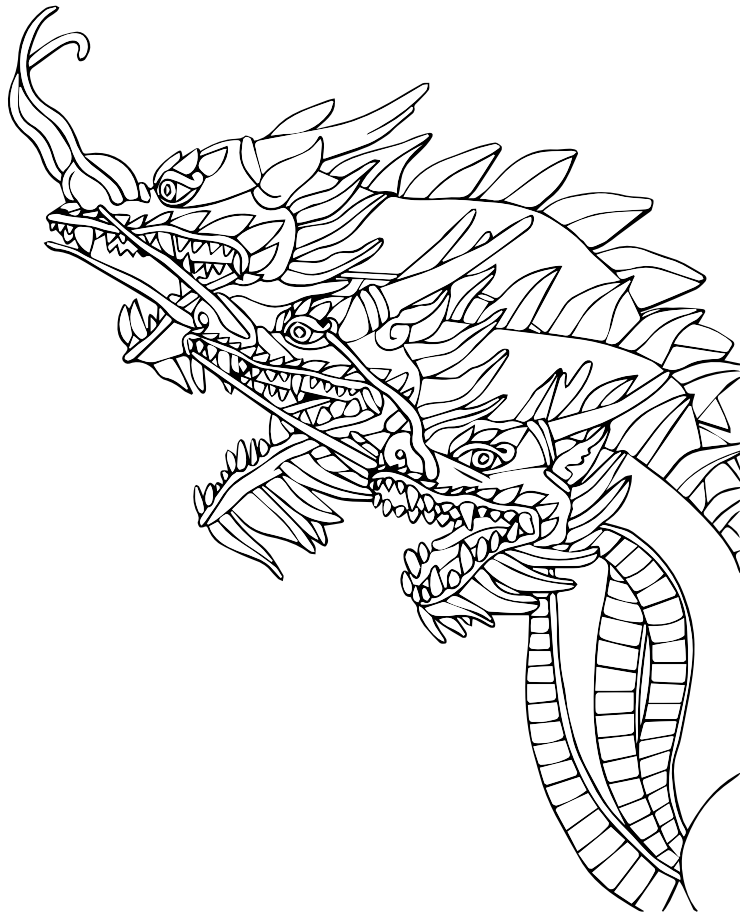

trójgłowy smok
триголовий дракон

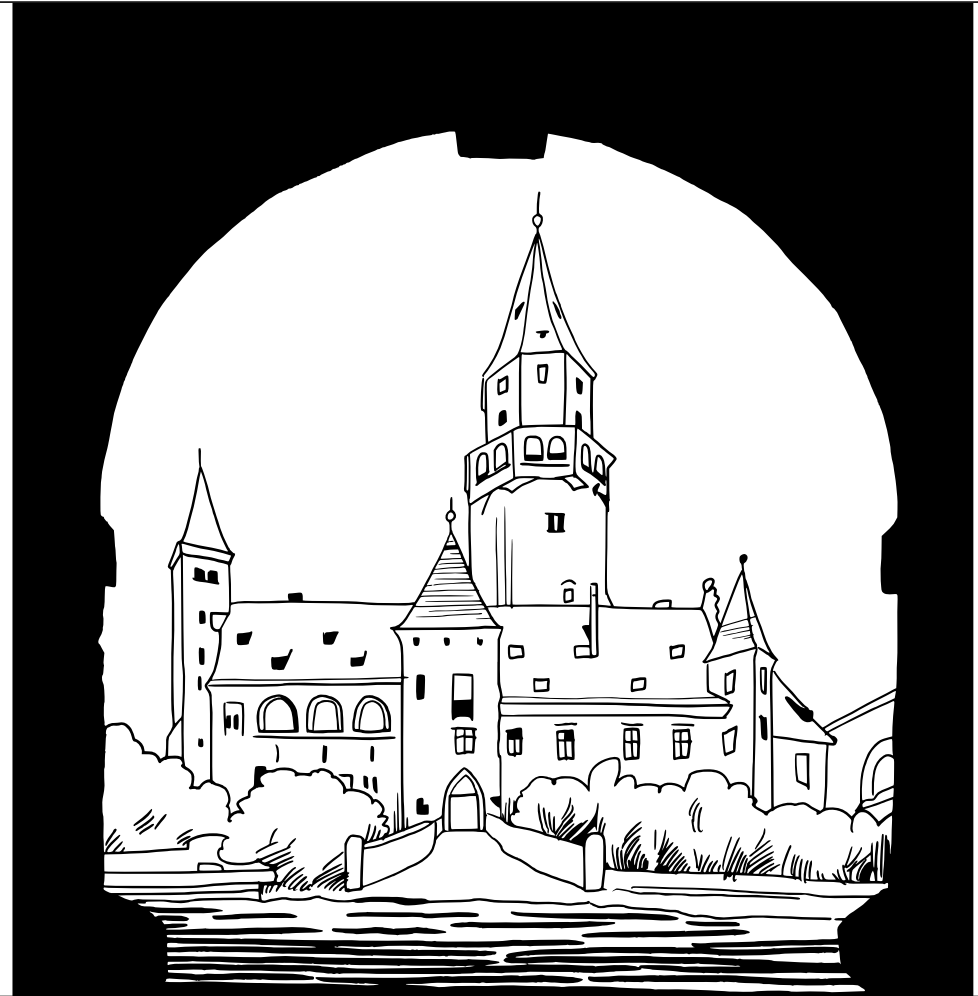

zamek
замок

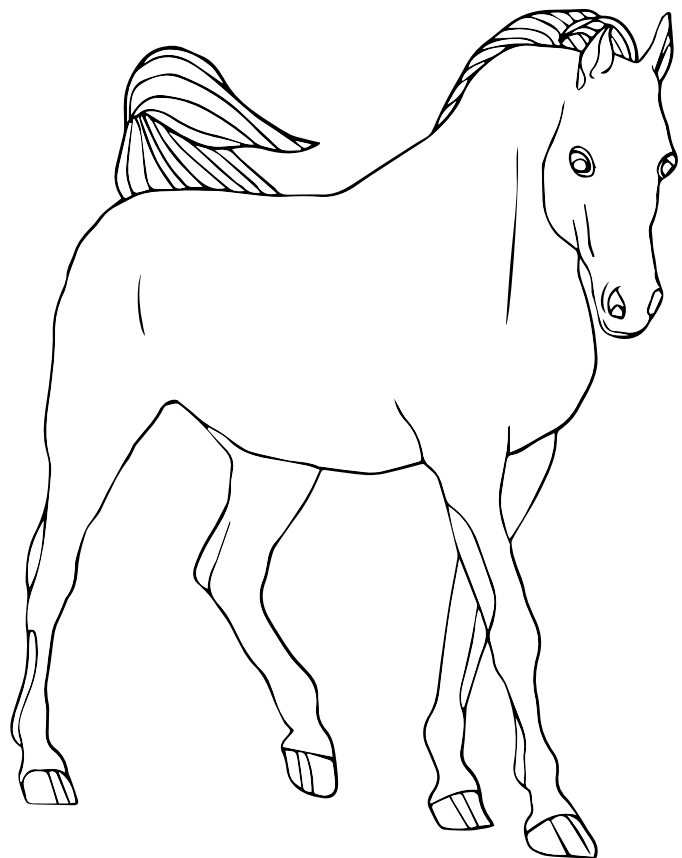

koń
кінь



wino gotowane
глінтвейн

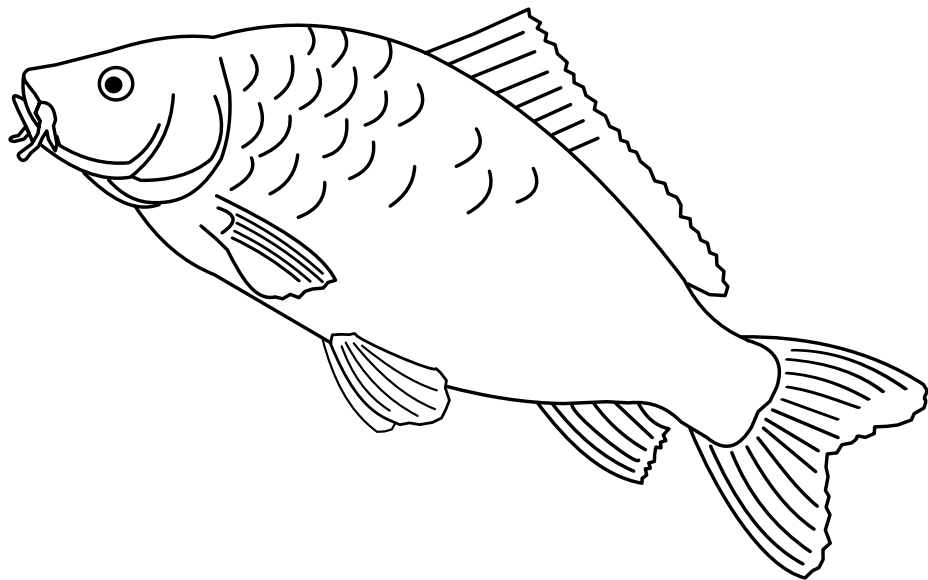

karp
короп

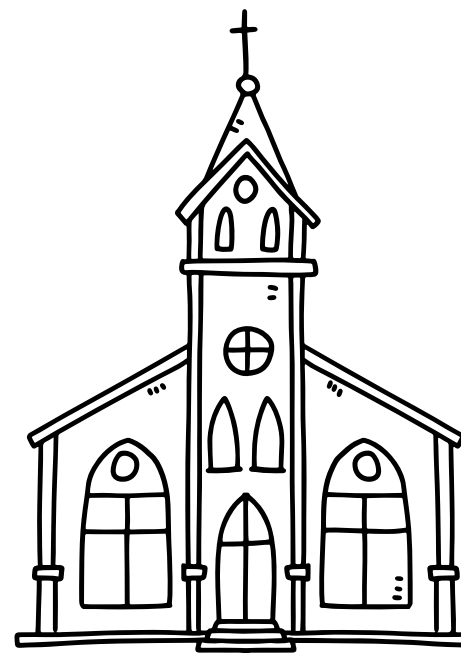

kościół
костел

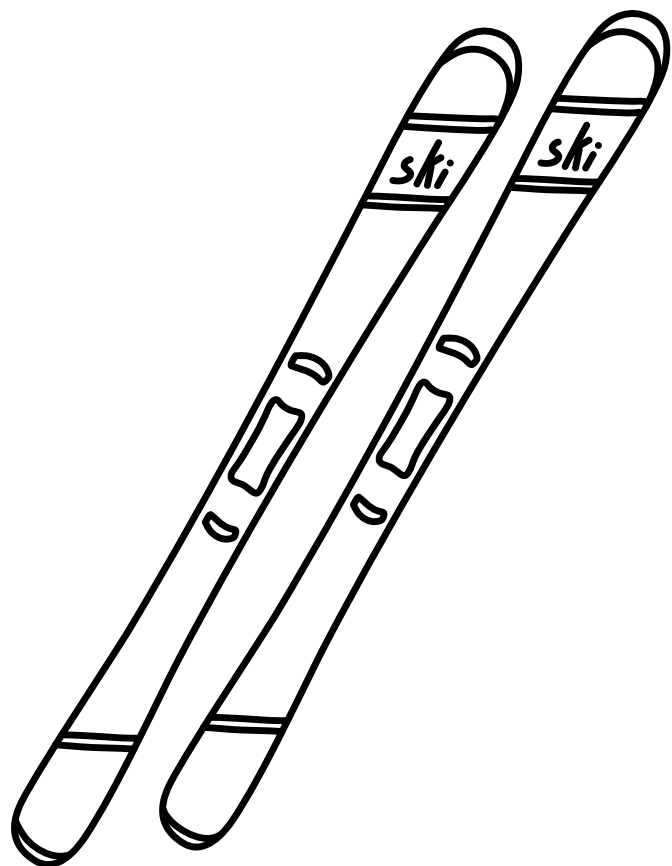

narty
лижі

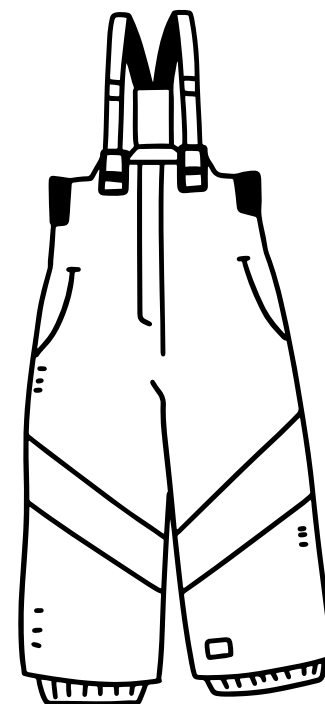

spodnie narciarskie
лижні штани

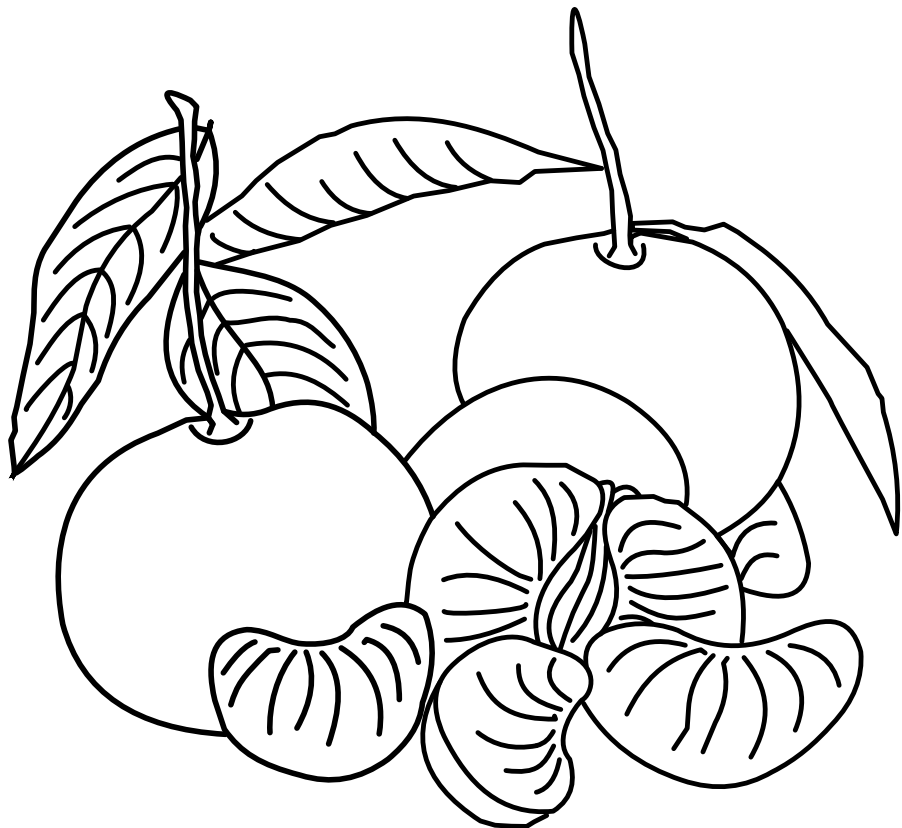

mandarynki
мандаринки

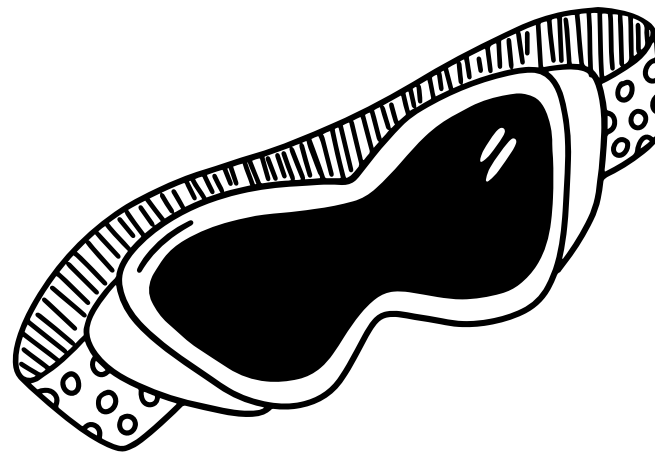

okulary
окуляри



jemioła
омела

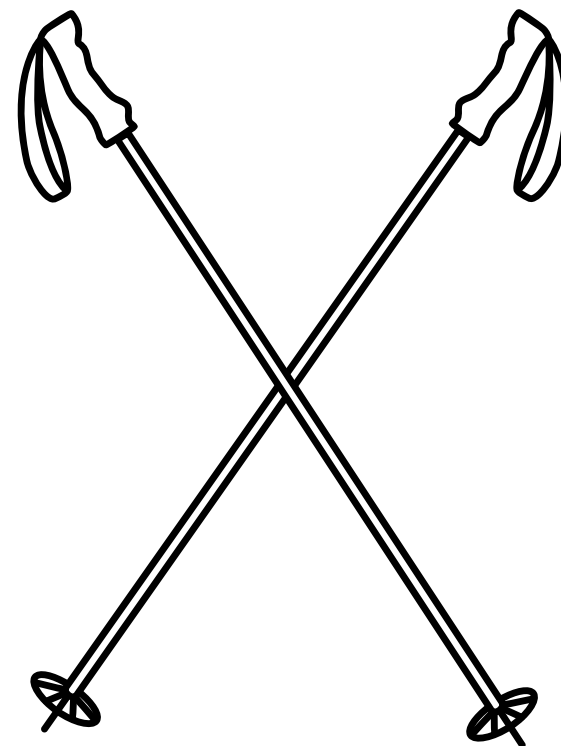

kijki
палки

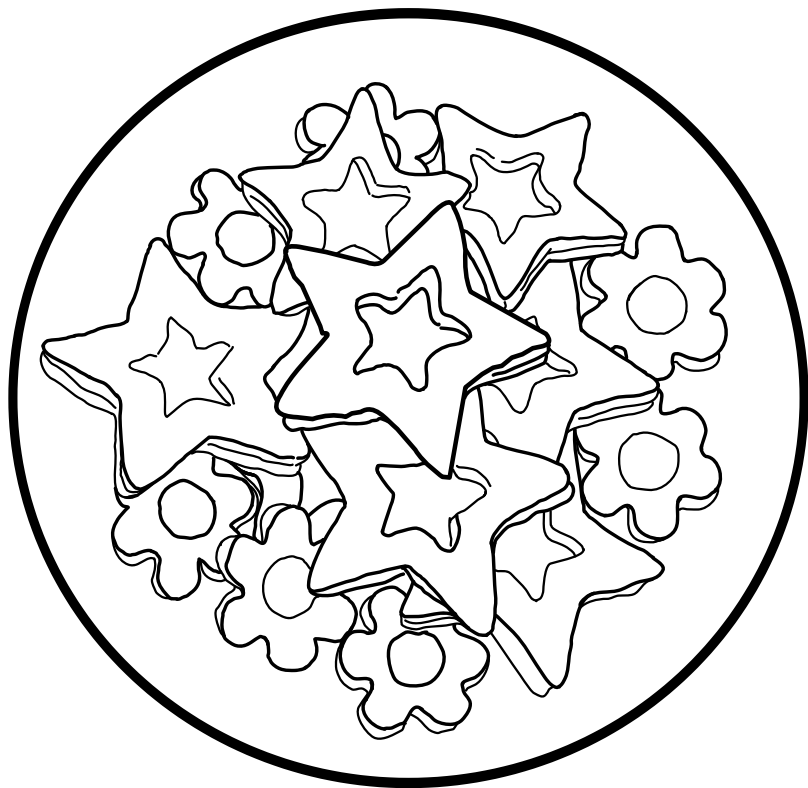

kruche pieczywo
печиво з пісочного
тіста

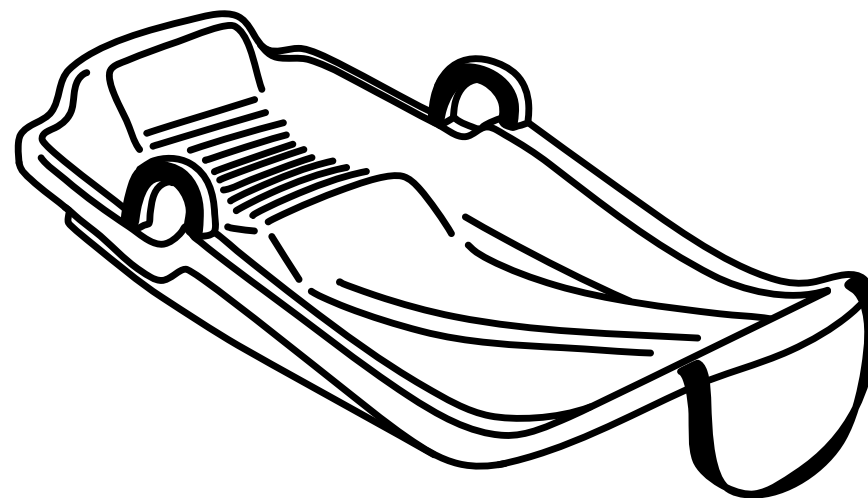

plastikowe sanki
пластикові санчата



prezent
подарунок



pierniki
прянички

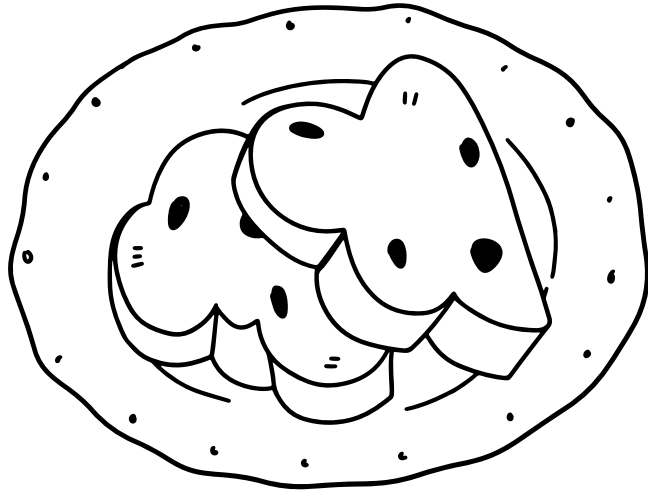

chałka świąteczna
різдвяна булочка-
плетінка

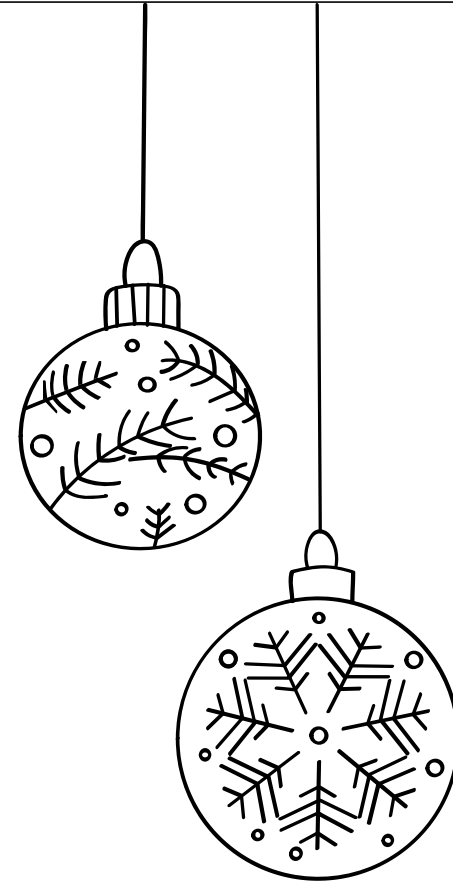

ozdoby
bożonarodzeniowe
різдвяні прикраси

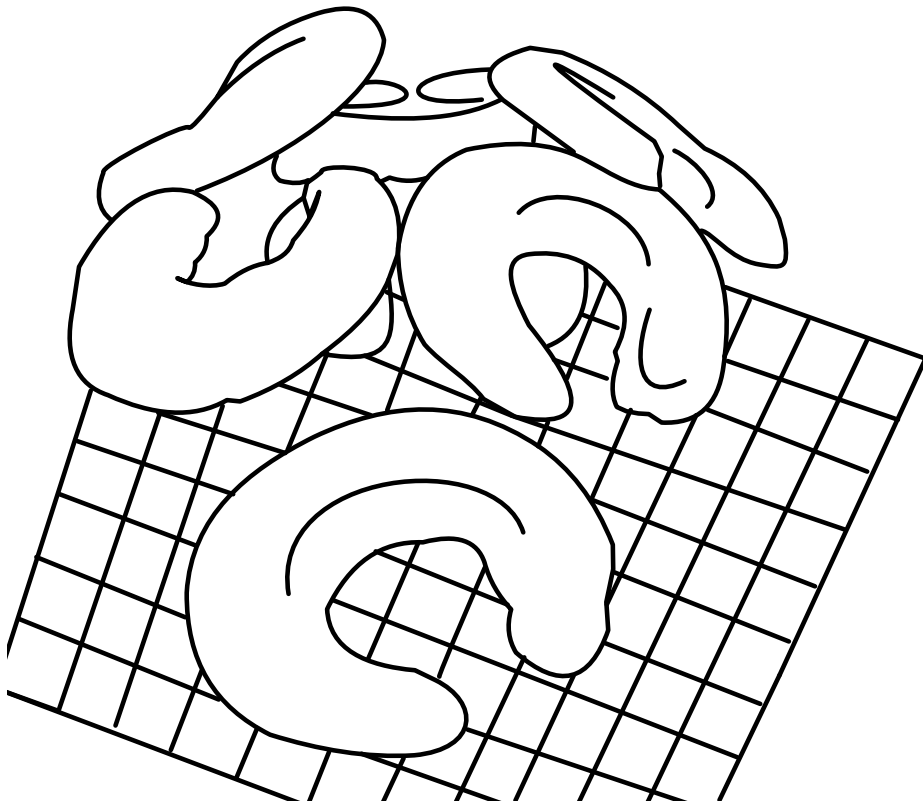

rogaliki
рогалики

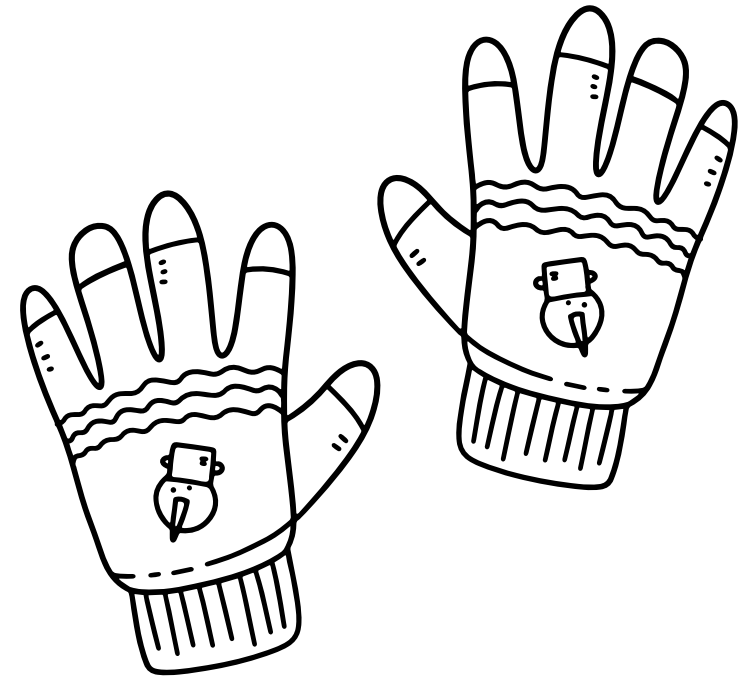

rękawice
рукавиці

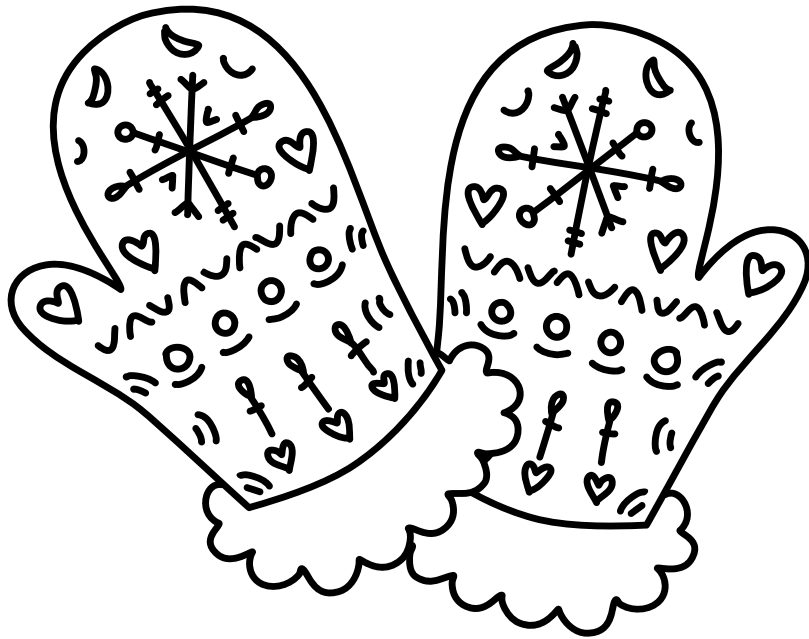

rękawice bez palców
рукавиці (без
пальців)

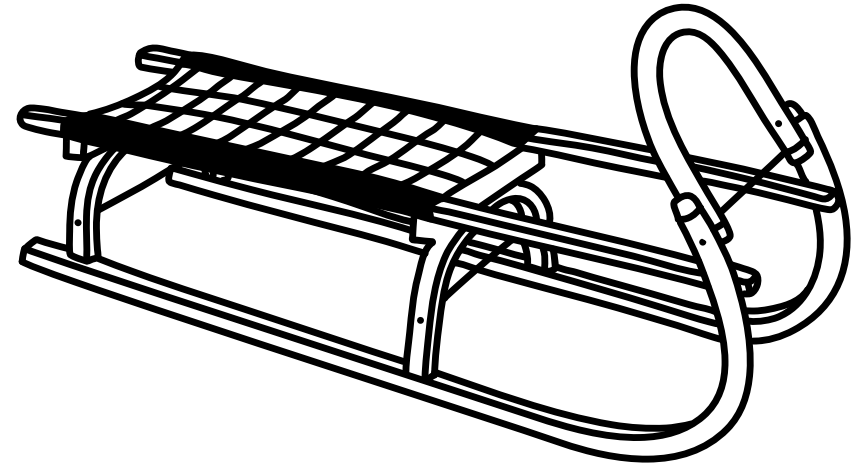

sanki
санчата

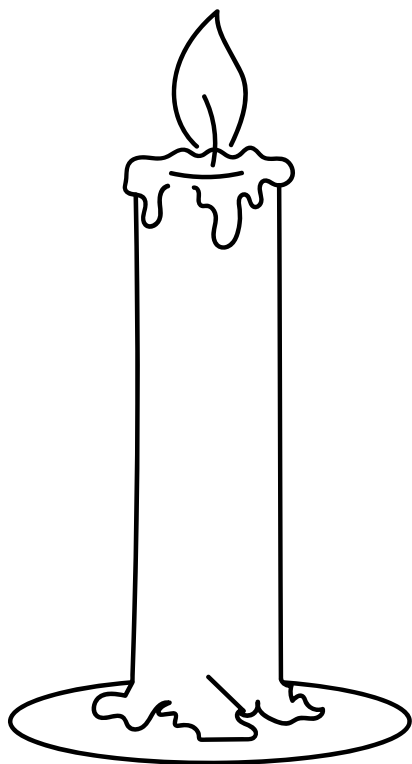

świeczka
свічка

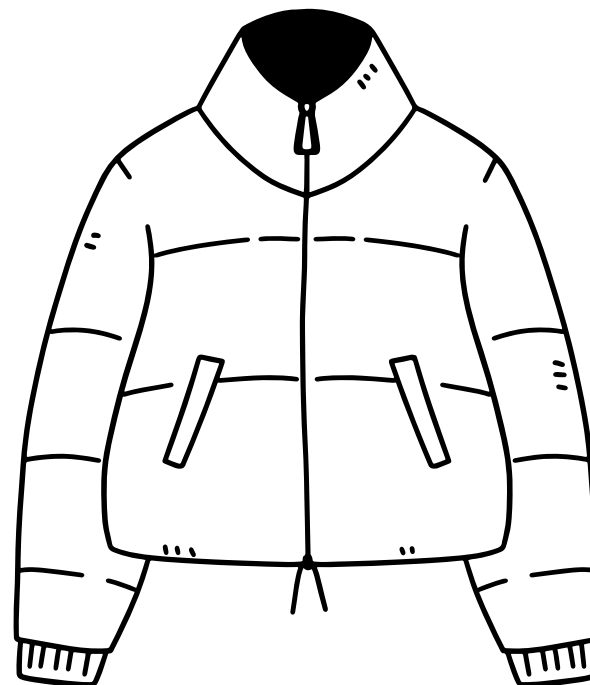

ciepła kurtka
тепла куртка

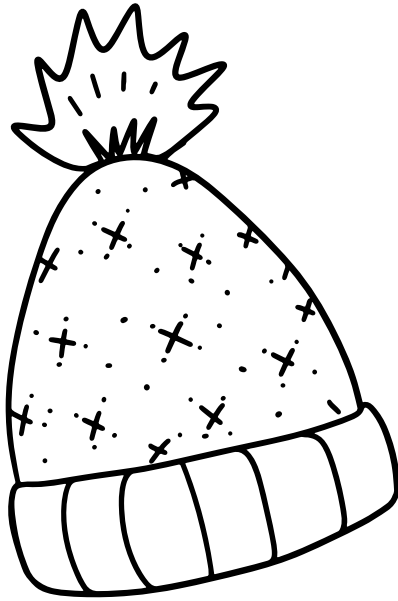

czapka
шапка

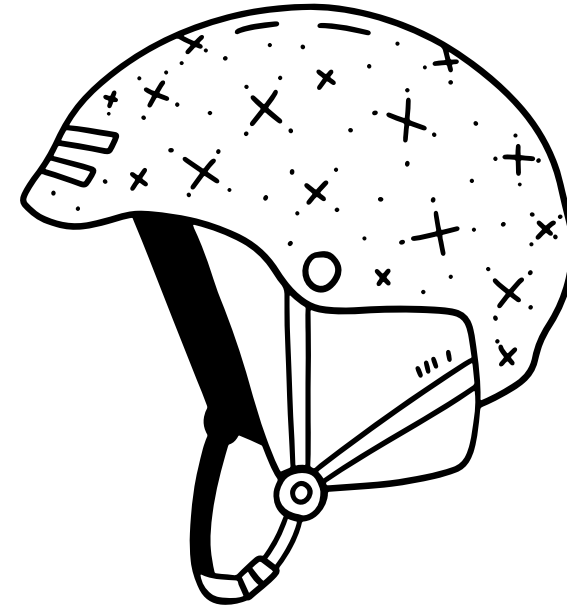

kask
шолом

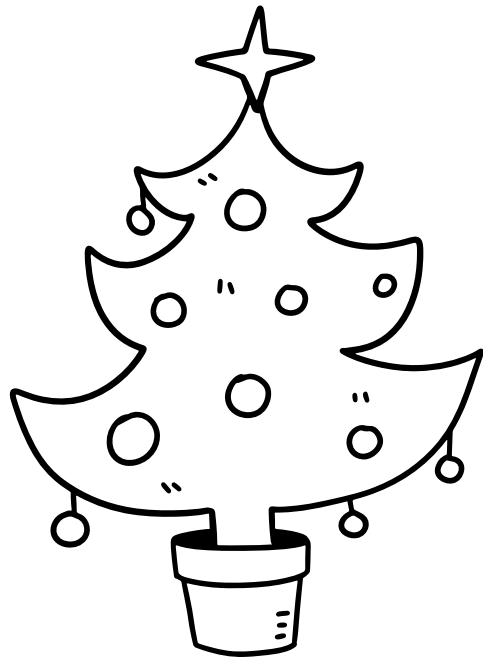

choinka
bożonarodzeniowa
ялинка



buty do nart
лижні черевики